



ELEGANT
FURNITURE & LIGHTING™

Installation manual for 2117G60C/RC

Dimensions : L60" W7.5" H7" L14

Collection : CUVETTE

Bulb Type : G9 bulb, not include bulb

Lamp Frame Weight : 43.12 LBS

Total Weight : 49.72 LBS



Thank you for choosing our product(s).

Our Company is actively involved in every step of the production.

Our product(s) are designed to be utilized for every application that graces your home or business.

We pride ourselves in providing the most prompt and courtesy service to all of the valued customers.

Please find the enclosed detailed instruction and read carefully for proper installation.

If you have any questions, please contact the retailer Where the purchased was made.

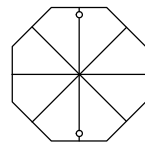

SAFETY

Warning: MAKE SURE THE ELECTRICITY TO THE WIRES YOU ARE WORKING ON IS SHUT OFF. BY EITHER REMOVING THE FUSE OR TURNING OFF THE CIRCUIT BREAKER.

CAUTION

- Before assembling the lighting fixture, please read all instructions carefully.
- All frame & crystal components are fragile, please handle with care.
- Required supply circuit : 110 - 130V/60Hz
- Labeled wires are "L" for live wire, "N" for neutral wire, "E" for ground wire.
- Never install fixture on damp ceiling, the room should be dry and well ventilated
- All electrical components must be installed by a licensed electrician and in accordance with the National Electrical Code and the appropriate local electrical codes.

Unpack the Package

Please open the box carefully and check all the items are inside the box. If you have any installation, assembling and missing parts questions. where you purchase from and any other relevant information ready, our customer service team will provide comprehensive and worry free service to our valued customers.

Frame Assembly Diagram

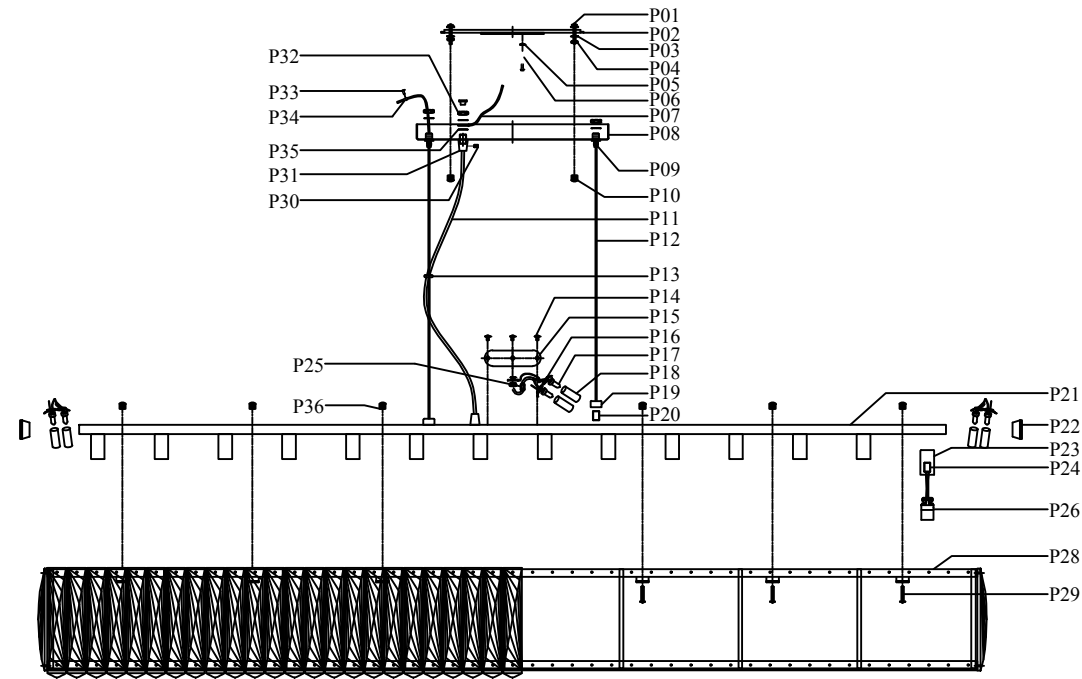





















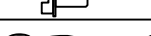





2117G60 D60" W7.5" H7" L14

Step 1













Please use the parts list to ensure you are not missing any parts.

2117G60

part	picture	Description	Qty	Check list
ZA		Electrical box(not include)	1	
ZB		GND	1	
ZC		Junction Caps	3	
ZD(P02)		Mounting bracket(L9.1"*W4")	1	
ZE(P08)		Canopy(L12.2"W4.7"H1",Chrome)	1	
ZF(P10)		M5 Knurled nut	2	
ZG		Mounting bracket screw	2	
P01		M4 Mounting bracket screw(L1.2")	2	
P02		Mounting bracket(L9.1"*W4")	1	
P03		Washer (Ø0.5"*T0.03")	4	
P04		M5 Hex nut	2	
P05		M4 Lock washer	4	
P06		Ground screw	1	
P07		GND	1	
P08		Canopy(L12.2"W4.7"H1",Chrome)	1	
P09		Cable adjustment bolt	2	
P10		M5 Knurled nut	2	
P11		Clear Round Electrical Wire(L138",18#)	1	
P12		Steel cope L118"	2	
P13		Plastic washer	2	
P14		M4 Flange bolt(L0.23")	3	
P15		Two holes steel bracket (L3.5"W1")	1	
P16		Cable tie	6	
P17		Junction caps	6	
P18		Heat shrink tubing	6	
P19		Metal finial(Ø0.8"H0.4")	2	
P20		M10 Nipple (L0.6")	2	
P21		Pipe (L55.1"H0.6")	1	

03

2117G60 D60" W7.5" H7" L14

Part	Picture	Description	Qty	Check list
P22		Pipe plug	2	
P23		Socket cover(Ø0.9"H1.7",Chrome,Iron)	14	
P24		M10 Nipple (L0.6")	17	
P25		Cable buckle	2	
P26		G9 Socket	14	
P28		Crystal frame body with crystal (L60"W7.5"H7")	1	
P29		M4 Mounting bracket screw(L1")	9	
P30		M4 Plastic Nipple	2	
P31		Power wire adjustment bolt	2	
P32		M10 Hex nut	30	
P33		M4 Nipple	4	
P34		Wire rope clamp	4	
P35		M10 Lock washer	18	

04

2117G60 D60" W7.5" H7" L14

Part	Picture	Description	Qty	Check list

2117G60 D60" W7.5" H7" L14

Part	Picture	Description	Qty	Check list

2117G60 D60" W7.5" H7" L14

Step 2

Canopy Installation Instruction

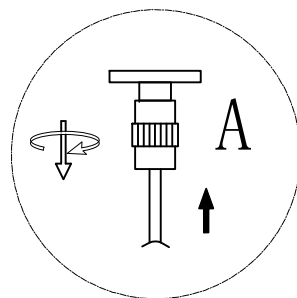
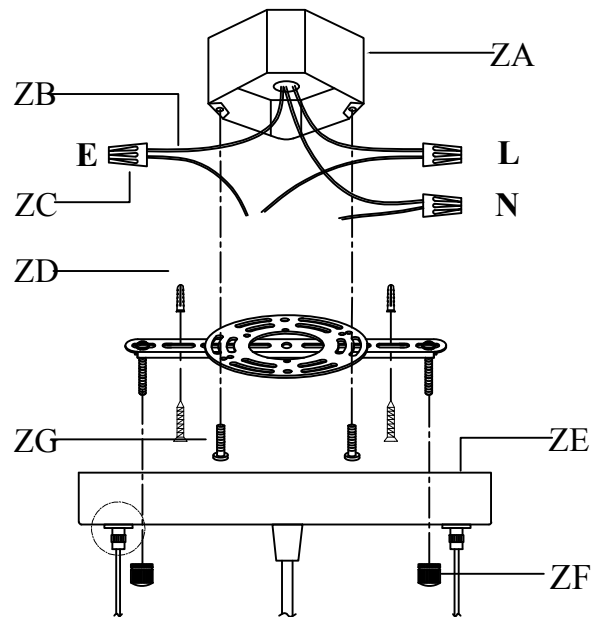

When adjusting the height of the steel wire, the telescopic metal part A toothed outer ring can only twist half a turn, and then pull it up to adjust the height!!!

"L"=Hot wire
"N"=Neutral wire
"E"=GND

07

2117G60 D60" W7.5" H7" L14

IMPORTANT: Test sockets with bulb before dressing the fixture.

1. Attach the Mounting bracket (ZD) to the electrical box (ZA).
2. Pull wires up through the Junction Caps (ZC).
3. Attach the Canopy (ZE) to the ceiling panel.
4. Make the electrical connections as detailed in the drawing above.

08

Step 3

Frame Assembly Diagram

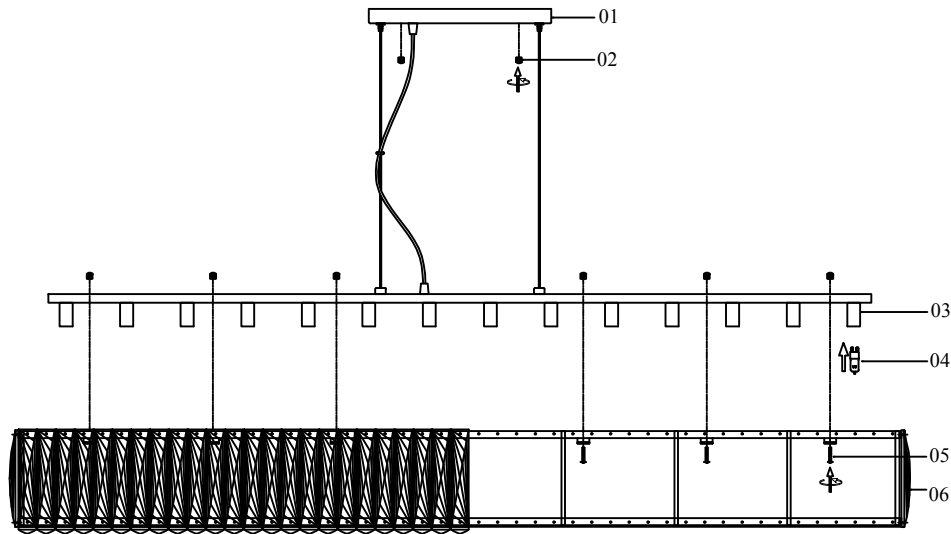

09

Frame Assembly Instructions

Installation:

Please read all instructions carefully. Before you proceed to install make sure that the power supply is turned off and remains off until installation is complete. Please note that each part has been assigned a number. Please proceed in a numerical order.

1. Install G9 Bulb(04) to G9 Socket(03).
2. Put the Light body ring on Crystal frame body with crystal (05).
3. Use Knurled nut(02) to fasten Canopy(01) together with Mounting bracket of Ceiling panel.

10

Congratulations !

You are now done installing your Elegant Lighting fixture. Sit back and admire each crystal as it will become the statement piece for your room/house.

Thank you.

Cleaning and Maintenance of Chandelier Frame
The finish on our chandelier frames and fixture frames is protected by a durable coating of lacquer. To clean, use a clean soft, dry cloth. Do not use any metal polishes, cleaners, abrasives or any substance which could remove the protective finish. Failure to follow these instructions automatically voids the guarantee.

Cleaning and Maintenance of Crystals
Wet a soft cotton fabric in clean warm water and wipe gently, then polish with a dry soft cotton fabric.

To Order Crystal Replacement Parts
Should you require replacement crystals or pins (the metal connectors attaching the crystals), contact the store where the product was purchased or contact us . For ease of ordering, you may use the original crystal trimming instructions provided with this product and circle the items you wish to order, indicating the quantity by writing the number needed adjacent to the circle . You will be contacted with prices prior to shipment. All orders must be pre-paid.